

**Mechanical interlocking at Kalamazoo, Mich., is replaced by power switches and signals which are controlled by a machine in a tower one-half mile away**

The control machine includes a track diagram and five levers

At a track layout at Botsford West End, 0.8 miles east of the passenger station at Kalamazoo, Mich., the Michigan Central formerly had a 16-lever mechanical interlocking plant which handled several switches, cross-overs and signals in a track arrangement including turnouts to a yard, passing tracks, and leads to an engine-house. As a result of constructing a grade separation, including an underpass for U. S. highway 12A, the tracks in this vicinity were raised about 10 ft., which necessitated several rearrangements of the tracks and switches, to the extent that extensive reconstruction of the mechanical interlocking would have been required. Rather than make extensive expenditures for rebuilding this interlocking, the old plant was retired, and power switches and light signals, controlled by a small desk machine in an existing tower one-half mile west, were installed to make a complete remote control system.

The revised track layout at Botsford West End includes switch No. 5, leading to a passing track on the north side of the double-track main line, and switch No. 6, leading to a passing track on the south side of the main line. From the passing track on the south, turnouts lead to the freight yard and to the enginehouse. Two three-arm high signals and three dwarfs were installed. Provision is made in the track layout as well as in the signal and control arrangement, for a crossover to be installed later

between the two main tracks within the plant limits.

The traffic through this plant includes 18 passenger trains and 12 scheduled freight trains daily. Botsford yard is used primarily for setting out or picking up Kalamazoo cars. The switch engines serving the numerous industries in Kalamazoo and vicinity distribute cars from this yard and return with cars to be forwarded. Four branch lines extend out of Kalamazoo, one to Battle Creek, Mich., one to Grand Rapids, one to South Haven and a fourth to White Pigeon. Trains for these branch lines are made up and also terminate in Botsford yard,

and the locomotives are serviced in the enginehouse at the yard. All of the branch line trains pass through the new remotely controlled plant when arriving or departing from the yard. When business is good, a total of from 50 to 75 movements will be made over the Botsford West End plant daily.

### The Control Machine

The machine for controlling the Botsford West End plant is of the desk type, and is located on the operator's desk in Tower 2 at an interlocking at a crossing of the Michigan

## Remote Control on the

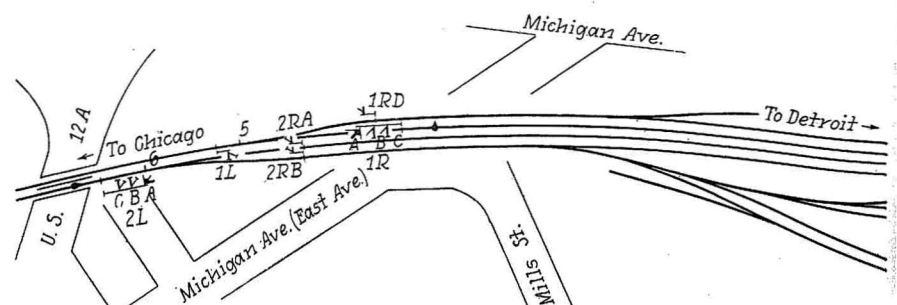

Track and signal diagram of Botsford West End



View looking west showing dwarf signals 2RA and 2RB

Three-“arm” signal 1R, showing fast eastward freight train

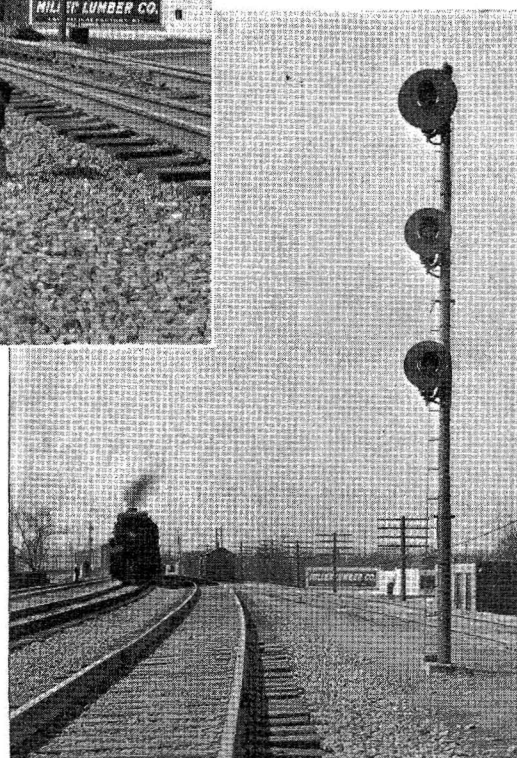

# Michigan Central

Central with the Grand Trunk Western, located one-half mile west of Botsford West End. This new control machine, as shown in one of the illustrations, includes an illuminated track and signal plan, at the top of the panel. Two three-position signal levers, No. 1 and No. 2, are located in the top row, and three two-position switch levers, No. 5, No. 6 and No. 7, are located in the bottom row. The middle switch lever, No. 7, is a spare, being provided for control of the proposed crossover mentioned previously.

A lamp in the face of each signal lever is lighted to indicate white when the corresponding signal clears. A push button above each signal lever can be used, in conjunction with proper setting of the corresponding signal lever, to control the bottom “arm” call-on aspect of each high signal, such as 2L-C and 1R-C. When a switch lever is operated, a clear lamp in the face of the lever is lighted and stays lighted until the switch has moved to, and been locked in, the position corresponding to that of the lever. In other words, this is a transit light. The small red lens below each switch lever is a hands-off

indication, being lighted when a route is lined up and the switch is locked in proper position. Under such circumstances, movement of the switch lever would not effect any change in the position of the switch.

If a route is lined up and the signal cleared for an approaching train, and the operator desires to change the line-up, he can place the signal lever normal thus changing the signal aspect to stop, but the position of a switch will not change, regardless of whether he operates a switch lever, until an automatic time release has operated. When a high signal is involved, the time release operates in 180 sec., but for a dwarf signal the time release operates in 60 sec. As long as the time limit is in effect, the hands-off lamp below the switch lever is lighted.

## General Construction Features

The signals used on this plant are the Type-SA, searchlight type. The circular backgrounds for the top “arm” on each high signal are 36 in. in diameter, and the backgrounds on the two lower arms are 24 in. in diameter. The switch machines are

the Model-5D, with dual control. Facing-point locks and point-detectors are provided. Raco switch feet and connections are used. These machines operate and lock up in 9 sec.

## Instrument Houses

At the Botsford West End location, the relays, battery, rectifiers and other instruments are located in three instrument houses; one, 4 ft. by 4 ft., is located at each high signal, 2L and 1R, and another 8 ft. by 8 ft., is at a central location. These houses are of wood frame construction, lined with ¼-in. asbestos board, and the walls are packed with rock wool to provide heat insulation and fireproof characteristics. The doors are of heavy construction and are insulated. A concrete foundation and floor is provided in the larger house, thus further increasing the protection against fire.

The batteries are located on a shelf at the floor line. The power switch machines are operated from a set of 12 Exide DMGO-7 cells, charged by 2 BT size 232 rectifiers. Each track circuit is fed by an Edison storage cell, Type-A-8, charged by a BX116

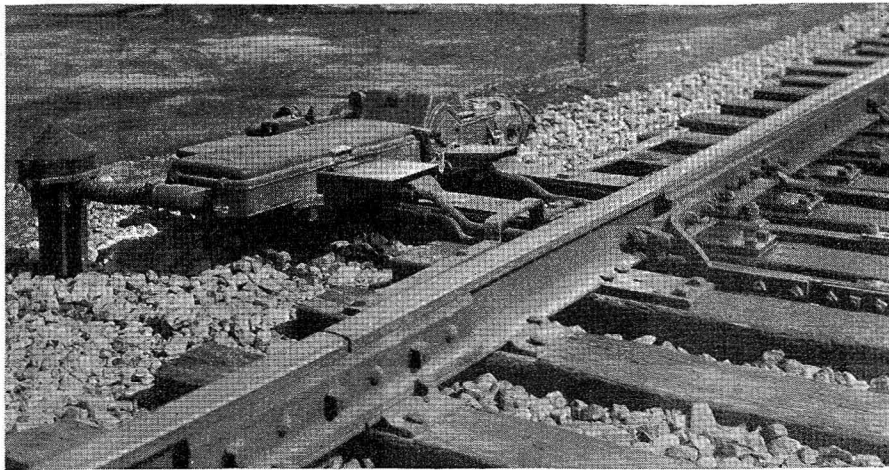

Typical power switch showing dual-control machine. Note special switch-foot connection

rectifier. A set of seven Edison Type B-4 storage cells is located at each signal.

The instruments are the wall type and are mounted on strips of 1 in. by 4 in. pine, run horizontally on the wall of the house. All incoming wires and cables terminate on Everett strip terminals mounted on the wall at one end of the house. Jumpers of No. 14, 19-strand insulated wire extend from these terminals through insu-

the Botsford West End plant are in two 19-conductor, No. 14 aerial cables, run in Copperweld rings, suspended from 5/8-in. stranded Copperweld messenger on the line poles. The circuits from the houses to the switches and signals are in underground parkway type cable. A 4-conductor, No. 8, cable extends to each switch and a 20-conductor, No. 14, to each signal.

A telephone circuit extends from

are typical of the entire installation. One line wire, as for example NR6W3, in connection with a split-battery common controls the operation of each switch. This same wire is used to bring in the indications of the signals controlled by lever 2. One line wire, such as 6WPP, is required to bring in the indications of the position of switch No. 6. One line wire, such as RL2, is used to control all of the signals controlled by signal lever 2, with the exception of the bottom call-on "arm" 2LC, and to clear this aspect line wire 2LC is required in connection with the push button.

A special item to be noted before studying the diagram is that the top arm, signal 2LA, is left normally

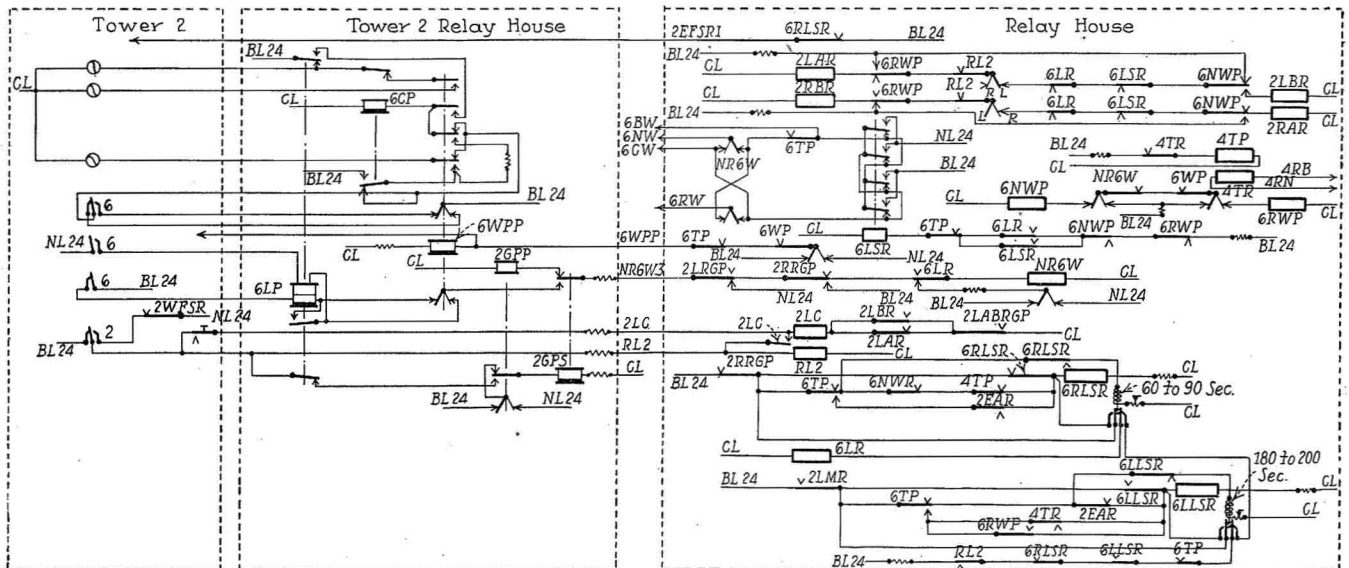

Diagram of control circuits for switch No. 6 and signals for routes over this switch

lated bridle rings, made of No. 10 insulated line wire, to terminal posts on the instruments, thus eliminating terminals on the wall at the instruments. The tags are of the strip type with two holes, so made that they stay in position on the wire and cannot slip off over the wire eyelet. All instrument terminals carrying more than 10 volts are equipped with Raco insulated nuts to prevent accidental short circuits. A Raco wound resistor is used in series with each line relay.

The circuits between Tower 2 and

Tower 2, jacks being provided in the various instrument houses so that the maintainer can plug in a hand set. A loud-ringing bell at Botsford West End is provided so that the towerman can call the maintainer.

**Circuit Arrangements**

As the distance from the control machine to the Botsford West End layout is only 1/2 mile, direct-wire control circuits are used. The circuits, as shown in the accompanying illustration for the eastward track,

clear, which accounts for signal repeater relays 2GPP and 2GPS being normally energized, rather than de-energized, which is the case when signals controlled by lever 2 are all indicating stop.

Referring to the control of switch No. 6, the two contacts operated by switch control lever No. 6 operate the polarized switch control relay NR6W to the two respective positions. Relays 6NWP and 6RWP repeat the normal and reverse positions of the switch. A circuit through contacts of these relays and the track relay of



the detector section 6T controls the switch-repeater relay 6WPP at the tower. Relay 6LSR is a lock relay, which must be energized to feed battery to the contacts of NR6W to operate the switch. Relay 6LP at the tower repeats the position of switch lever 6. With the lever in the normal position, the switch normal, and all signals at stop, relay 6LP will be energized because relay 2GPS will be de-energized when signals 2L and 2R are at stop. With the switch reversed, signal 2R and 2L at stop, relay 6LP is de-energized.

### Special Feature

The purpose of the lever-repeater relay 6LP at the tower is to provide an arrangement so that a circuit to 6RWP can start from either a normal or reverse position contact of lever No. 6. Relay 6LP has slow-release characteristics to prevent the relay from dropping while the lever is being moved from one position to another. When studying this diagram, the fact must be noted that signal 2LA is normally clear, and that relay 2GPP and 2GPS will be released when signal 2LA is changed to indicate stop. With relay 2GPS released, and switch lever 6R normal, BL24 feeds through the contact on the lever

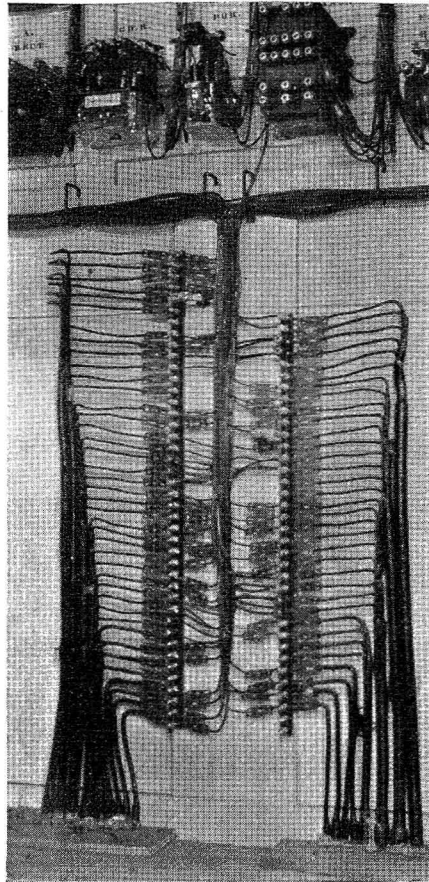

Left—Interior of housing at Signal 2L. Above and right—Interior of large centrally located housing showing method of mounting the instruments

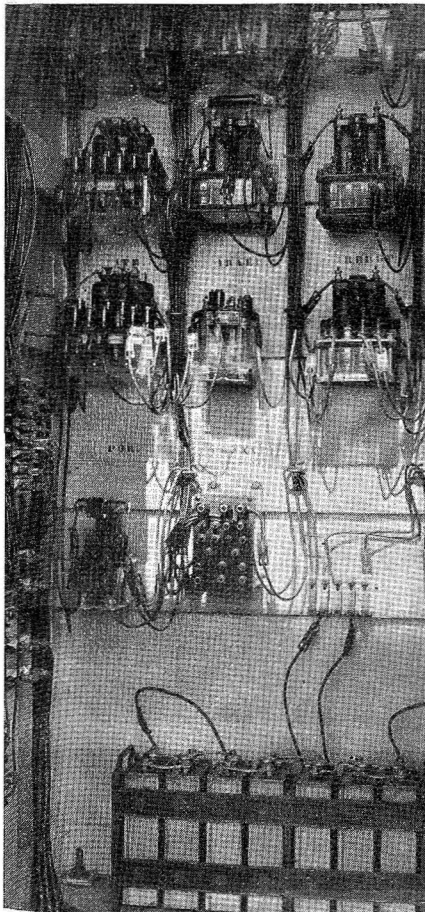
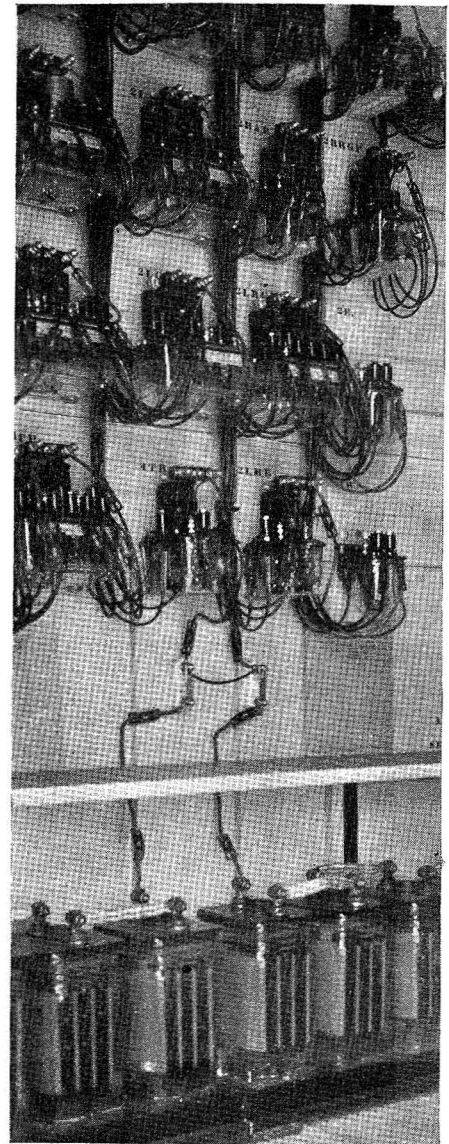

to energize relay 6LP and continues through contacts and wires N6W6, NR6W5, NR6W4, etc., to energize relay NR6W in the position as shown. Then when switch lever No. 6 is reversed, closing a contact to NL24, a circuit is completed through the contact of 6LP to wires N6W6, NR6W5, NR6W4, etc., to permit split battery to energize NR6W in the reverse position. Switch lock relay 6LR and stick relay 6LSR would have been energized when signal 2L was placed at stop, providing the track circuits were not occupied. Therefore, when relay NR6W was energized in the reverse position, battery was fed to operate the switch. If the signal lever 2 is reversed to pick up relay RL2 before the switch has completed operation, 2LR will be released, but relay 2LSR sticks up to cause the switch to complete its operation, and stays up as long as both switch position repeating relays 6NWP and 6RWP are down. 6NWP is normally energized when the switch is in

the normal position, but this relay was de-energized when relay NR6W was reversed by the operation of lever 6.

After the operation of the switch to the reverse position is completed, relay 6RWP is picked up, causing relay 6LSR to be released, thus opening the feed to the machine, and also the position of the switch position repeater relay 6WPP is reversed, causing proper indications to appear on the control machine.

All of the signals controlled by lever 2 are controlled by relay RL2, over wire RL2, and in addition relay 2LC, controlled over wire 2LC and the push button, is used to control the bottom call-on arm 2LC on signal 2L. Indications of signal aspects displayed are handled over the switch control line wire NR6W3.

This remotely-controlled plant at Kalamazoo was planned and installed by signal department forces of the Michigan Central, the major items of signaling materials being furnished by the General Railway Signal Company.